



SECTIONAL GARAGE DOORS

NEW. Duragrain decors matching aluminium entrance doors Decoral

HÖRMANN





4

Good reasons
to try Hörmann
sectional doors.



14

Door styles.
Inspirations.



48

Design.
Equipment.
Accessories.

Responsibility for generations

The Hörmann family business has over 85 years of experience as a construction component specialist. This gives us an obligation to both current and future generations. That's why environmental responsibility plays such an important role for us. With this in mind, we develop innovative solutions for sustainable products and intelligent environmental protection.



“A GOOD REPUTATION MUST BE EARNED.”

August Hörmann

In keeping with the tradition started by the company's founder, the Hörmann brand is a true promise of quality and, with sales of over 20 million doors and operators, is one of Europe's most successful suppliers. Due to the comprehensive international sales and service network, Hörmann is your strong partner for high-quality construction components.



WE THINK AND ACT GREEN. As a family business, we are very conscious of our responsibility to future generations. The Hörmann climate protection strategy aims to reduce and avoid CO₂ emissions. We cover 100% of our electrical power needs at all European production locations with purchased green electricity. We are also investing in a clean future with other measures such as the use of recycled paper, CO₂-neutral postal shipping and the recycling of transport packaging to save more than 75,000 tons of CO₂ every year. We work with ClimatePartner to offset the emissions that we do generate by supporting certified climate protection projects. In particular, we offset all CO₂ emissions produced in manufacture of products for residential construction as standard.



You can find further information at
www.hoermann.com/sustainability



ClimatePartner
certified product
climate-id.com/XNEBKC



CO₂
measure
reduce
contribute

Brand quality made in Germany



The family-owned company Hörmann offers all important construction components for building and renovating projects from a single source. We manufacture in highly specialised factories using state-of-the-art production technologies. Our employees work intensively on new products, continual further developments and improvements to details. The results are patents and unique products on the market.





10-year
warranty*

LONG-LASTING. GUARANTEED. All major door and operator components are developed and manufactured by Hörmann. Endurance tests under real conditions ensure mature series products with Hörmann quality. Thanks to this and uncompromising quality assurance, you receive a 10-year warranty on all Hörmann sectional doors and a 5-year warranty on Hörmann operators*.

* The complete warranty conditions can be found at: www.hoermann.com



Tested and
certified

CERTIFIED SAFETY FOR YOU AND YOUR FAMILY.

Hörmann sectional doors are tested and certified in accordance with the high safety requirements of European standard 13241, not only on their own but also in combination with Hörmann operators. It would be hard to find a safer sectional door. And this provides you and your family with safety during daily use.



Space-saving opening and secure closing

Sectional garage doors open vertically upwards and are suspended under the ceiling to save space. This construction principle means you can make full use of the space inside and in front of the garage. Sectional garage doors can be fitted in any garage opening and offer extra passage width. Treat yourself to this comfort and convenience.





CERTIFIED RC 2 SECURITY FEATURES

In addition to the standard anti-lift kit, which automatically locks your door securely and protects it against being forced open, the sectional garage door LPU 67 Thermo and optionally the LPU 42, wicket as well as side doors come with certified RC 2 security features as standard.

→ For further information, see from page 71.



Take a look at the video on YouTube or at www.hoermann.com/en/media-centre



MORE PASSAGE WIDTH. Sectional doors with a passage width extended by up to 14 cm also make it much easier to park modern, larger vehicles and SUVs (shown in centre). With older up-and-over doors, driving in and out is often a matter of millimetres (shown at the bottom).



Intelligent operating comfort

Control your garage door and entrance gate operators, door operators, entrance door locks, lights and other devices simply, safely and conveniently via hand transmitter, radio switch or smartphone. All operators, receivers and control elements with BiSecur radio technology are 100% compatible with each other.





Only from Hörmann

CERTIFIED SECURITY. The bidirectional radio system BiSecur with particularly secure encryption protocol and stable, interference-free range makes sure that no one can copy your radio signal. This is also confirmed by the security experts of Bochum University and independent test institutes.



Take a look at the video on YouTube or at www.hoermann.com/en/media-centre

INTELLIGENT TECHNOLOGY. Hörmann operators offer more convenience, smart functions and intelligent technology. The automatic safety cut-out stops the door securely and reliably if it encounters an obstacle. Your door opens and closes quietly and smoothly with the soft start and soft stop. Our elegant hand transmitters allow you to open your door from your car, for example. Or you can simply use your smartphone as a door opener with the Hörmann BlueSecur app or the Hörmann Smart Home control centre homee.

→ For further information, see from page 76.

Thanks to the standard automatic safety cut-out, children can play in your yard without worrying.



With the Smart Home control centre homee, you can control all door functions via your tablet or smartphone.



Choose the door that suits your home.

No matter the architectural style, with Hörmann, you are guaranteed to find a sectional garage door style to fit your personal preferences and home – from straight-lined ribbing to classic panelling in many surface finishes, colours and decors, as well as solid timber doors. Be inspired by the Hörmann variety on the following pages or configure your dream door conveniently online.





THE DOOR OF YOUR CHOICE IN JUST A FEW CLICKS. With the door configurator, you can conveniently test many design and product variations on your own PC or tablet in advance. You can put your dream door together in just a few clicks by selecting the door type, surface finish, colour and size and also see the recommended retail price of your configuration (shown on the top right). If you then upload a picture of your house and place the door in your garage opening, you can see in advance how well your new garage door will match your home.

INDIVIDUAL DURAGRAIN STYLES. You can also design the sectional garage doors with Duragrain surface finish yourself by using a custom image (shown on the top left). To do this, simply upload the image or contact your Hörmann sales partner.



The Hörmann configurator can be found at:

www.hormann.co.uk/uk/home-owners-and-renovators/configurator



GERMANY'S BEST-SELLING GARAGE DOOR. More than 5 million customers are convinced of the convenience, safety and design of Hörmann sectional garage doors.



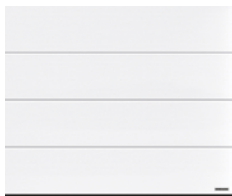

16 L-ribbed



26 M-ribbed



34 S-ribbed



36 D-ribbed

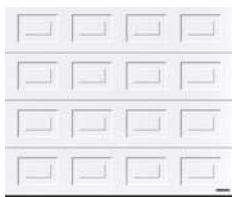

38 S-panelled



40 Solid timber doors

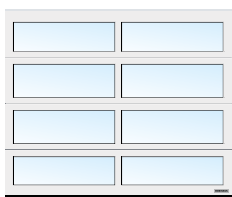

42 Glazed doors



44 Facade doors /
large doors



46 Hinged garage doors





HÖRMANN



PLANAR SURFACE FINISH. The exclusive surface finish available in 7 Hörmann Matt deluxe colours has a modern look. It impresses by combining a smooth surface finish with fine elegance and matt trendy colours.

→ Available as L-ribbed version. For all colours and details, see from page 62.





L-ribbed

→ Available in the Woodgrain, Slategrain, Silkgrain, Sandgrain, Planar, Decograin and Duragrain surface finishes. Further information can be found starting on page 51.

PAGE 16 / 17. Planar, CH 703 Matt deluxe Anthracite metallic

LEFT. Planar, CH 7016 Matt deluxe Anthracite grey, 3000 mm door height

BOTTOM LEFT. Detail view of Planar, CH 9006 Matt deluxe White aluminium

BOTTOM RIGHT. Planar CH 9006 Matt deluxe White aluminium, aluminium entrance door ThermoCarbon style 860 in White aluminium RAL 9006





SILKGRAIN SURFACE FINISH. Thanks to its elegant door appearance, this silky smooth surface finish is the first choice for modern architecture. A 50% thicker exterior sheet on the sections also ensures higher stability and even smoother running.

→ Available as L-ribbed, M-ribbed and D-ribbed version. For all colours and details, see from page 59.



L-RIBBED

TOP LEFT. Silkgrain, Jet black RAL 9005, aluminium entrance door ThermoPlan Hybrid style 871, Jet black RAL 9005

TOP RIGHT. Silkgrain, Traffic white RAL 9016

BOTTOM LEFT. Detail view of Silkgrain, Quartz grey RAL 7039

BOTTOM RIGHT. Design style 461, Silkgrain, Quartz grey RAL 7039 with glazing elements, Hörmann aluminium entrance door ThermoSafe style 173, Quartz grey RAL 7039



DURAGRAIN SURFACE FINISH. With this smooth door surface, you can choose from detailed, natural and true-colour decors or, if you wish, have your door printed with an individual image. The final coating of high-strength protective paint is especially robust, scratch-resistant and stain-resistant. As a result, your door maintains its attractive look. The garage door is available in combination with the aluminium entrance door ThermoSafe Decoral in five decors for a matching look. Thus, entrance and garage door form a harmonious unit – simply beautiful!

→ Available as L-ribbed version. For all decors and details, see from page 64.



For further information, see the "Entrance door and garage door with a matching look" brochure.



For further information, see the "Duragrain surface finish" brochure.



L-RIBBED

TOP LEFT. Duragrain concrete with matching side door

TOP CENTRE. Individual Duragrain style

TOP RIGHT. Duragrain Rusty Steel

BOTTOM. Duragrain Barnwood grey, matching aluminium entrance door
ThermoSafe Decoral .NEW





INTELLIGENT ACCESSORIES. You no longer have to go out in any wind and weather to check if your door is closed. At the press of a button, the colour of the LED on the hand transmitter HS 5 BS or the internal push button FIT 5 BS indicates the door position. If required, another push of a button* closes the door. Or you can simply use your smartphone as a door opener with the Hörmann BlueSecur app or the Hörmann Smart Home control centre homee. It is the most convenient and secure way to control your door.

→ The accessories are available for all sectional garage doors.

* An additional photocell is required for operation without visual contact to the door.



LIGHT SOLUTIONS. An LED light strip puts your door and side door in the right light. Hörmann key switch posts offer you more light and security in your yard entrance.



TOP LEFT. L-ribbed Silkgrain, Anthracite grey RAL 7016, aluminium entrance door ThermoSafe style 504 in Anthracite grey RAL 7016

TOP RIGHT. M-ribbed Silkgrain, Traffic white RAL 9016 with LED light strip as well as light key switch posts SLS-K

BOTTOM. Smart door operation with the Hörmann BlueSecur app

M-ribbed

→ Available in the Woodgrain, Slategrain, Silkgrain, Sandgrain and Decograin surface finishes. Further information can be found starting on page 51.



TOP LEFT. Woodgrain, Window grey RAL 7040

TOP RIGHT. Woodgrain, Slate grey RAL 7015

BOTTOM LEFT. Woodgrain, Traffic white RAL 9016

BOTTOM RIGHT. Detail view of Woodgrain,
Traffic white RAL 9016





WOODGRAIN SURFACE FINISH. On this inexpensive and robust surface finish with an authentic sawn timber look, minor scratches can be easily repaired.

→ Available as L-, M- and S-ribbed as well as S-panelled version. For all colours and details, see from page 59.

SLATEGRAIN SURFACE FINISH. Slate slabs are the model for this textured surface finish that gives your door a special look.

→ Available as L- and M-ribbed version. For all colours and details, see from page 59.





M-RIBBED

TOP LEFT. Detail view of Slategrain Traffic white RAL 9016

BOTTOM LEFT. Slategrain, Anthracite grey RAL 7016

TOP RIGHT. Slategrain, Traffic white RAL 9016, door version LPU 42 PremiumPlus with all-round protection for less corrosion in maritime climates **.NEW**

BOTTOM RIGHT. Slategrain, Anthracite grey RAL 7016





DECOGRAIN SURFACE FINISH.

The detailed surface finish is available in five natural-looking timber designs and with an Anthracite metallic effect. Your door remains beautiful for a long time thanks to the special surface protection with UV-resistant plastic film coating on the outside of the steel sections.

→ Available as L- and M-ribbed version.
For all decors and details, see from page 63.





M-RIBBED

TOP LEFT. Detail view of Decograin Golden Oak

TOP CENTRE. Decograin Golden Oak

TOP RIGHT. Decograin Dark Oak

BOTTOM. Decograin Titan Metallic CH 703





TOP. L-ribbed, Silkgrain, Basalt grey RAL 7012 with matching side door

BOTTOM LEFT. Single-leaf multi-purpose door MZ Thermo65, Traffic white RAL 9016

BOTTOM RIGHT. M-ribbed, Woodgrain, Anthracite grey RAL 7016 with wicket door

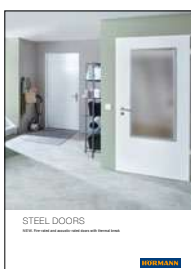

For further information, see the "Steel doors" brochure.





SIDE DOORS. The door as a second entrance to your garage is available in the same surface finishes, colours and decors as your garage door – if desired, also with exactly the same alignment of the ribbing. This ensures that everything fits together. If you value good thermal insulation and also want to reduce the risk of condensation forming on the inside, a multi-purpose door MZ Thermo with thermal break is the best choice for you.

→ For further information, see from page 72.

WICKET DOORS. A wicket door in the garage door lets you easily access gardening tools, bikes or wheelbarrows in your garage. The stainless steel threshold rail of the wicket door is only 10 mm high at the centre and 5 mm at the edges. This reduces the risk of tripping and makes it easier to wheel things through.

→ For further information, see from page 74.





MATCHCOLOR. Use matching colours for sectional garage doors, entrance doors, side doors and steel doors to design your home in perfect colour harmony.

→ Available for Woodgrain, Slategrain and Silkgrain surface finishes. For all colours and details, see from page 60.

S-ribbed

→ Available in the Woodgrain surface finish. Further information can be found starting on page 51.



LEFT. Woodgrain, Fir green RAL 6009

TOP RIGHT. Woodgrain Traffic white RAL 9016 with matching side door

BOTTOM RIGHT. Woodgrain, Anthracite grey RAL 7016 with matching side door and aluminium entrance door ThermoSafe style 501

INLAY DESIGN ELEMENTS. Give your door a very personal touch. The inlays in stainless steel or timber look as well as individually in RAL to choose are inserted into the ribbing of the sectional doors entirely according to your wishes (shown on right).

→ Available as M- and D-ribbed version. For all designs and details, see from page 55.

DESIGN ELEMENTS. Give your door a very special style. Choose one of our design styles or arrange and combine the brushed stainless steel design elements according to your wishes. House numbers or street names are possible as well.

→ Available as L- and D-ribbed version. For all designs and details, see from page 54.

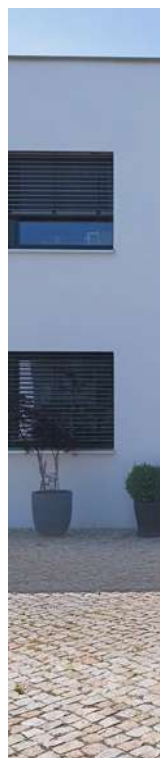



D-ribbed

→ Available in the Silkgrain surface finish.
Further information can be found starting
on page 51.

TOP. Silkgrain, Anthracite grey RAL 7016 style 500 with inlay in timber look

BOTTOM LEFT. Silkgrain, Grey aluminium RAL 9007 with design element
"house number", Hörmann aluminium entrance door ThermoSafe style
872, Grey aluminium RAL 9007

BOTTOM RIGHT. Silkgrain, Anthracite grey RAL 7016, aluminium entrance
door ThermoSafe style 860 in Anthracite grey RAL 7016



LIGHT ELEMENTS. Classic or Sunrise glazings are a perfect match for panelled doors and give your door a special look. Glazings are not just a design element, however, they also provide daylight in the garage.

→ Available for all door styles.
For all glazings and details,
see from page 57.





S-panelled

→ Available in the Woodgrain surface finish.

Further information can be found starting on page 51.



TOP LEFT. Woodgrain,
Traffic white RAL 9016

TOP RIGHT. Woodgrain,
Slate grey RAL 7015

BOTTOM. Woodgrain, Moss
green RAL 6005 with classic
glazing S2 in sandwich design

Solid timber doors

NATURALLY BEAUTIFUL. These doors made of untreated or brushed Nordic Pine are excellently suited for timber houses or buildings with many timber elements, such as timber framing or facade elements. Choose from six elegant door styles.

→ For further information, see from page 66.





LEFT. Door style 401, solid timber Nordic Pine, Glazed Larch

TOP RIGHT. Door style 405, painted white on site with hinged door fitting kits and decorative handles

BOTTOM RIGHT. M-ribbed, solid timber Nordic Pine, untreated

Glazed doors

ALUMINIUM FRAME DOOR ART 42 / ART 42 THERMO / ART 42 VITRAPLAN.

This door version with standard profile or profile with thermal break convinces with more light in the garage or with better ventilation in the parking boxes of collective garages if grille infills are used.

NEW from 01.10.2023. The flush-fitting glazing in front of the ART 42 Vitraplan is particularly appealing with its clean and extremely elegant look. The frame profile in Jet black RAL 9005 is concealed so that the overall view is not compromised.

→ For further information, see from page 56.





TOP. ART 42 Vitraplan, grey tinted .NEW from 01.10.2023

LEFT. ART 42 Thermo with synthetic double panes, frame in Anthracite grey RAL 7016, aluminium entrance door ThermoSafe style 650, Anthracite grey RAL 7016, optional side elements





Facade doors / large doors

INDUSTRIAL SECTIONAL DOOR ALR F42 FOR ON-SITE CLADDING FLUSH WITH THE FACADE. Design your sectional door according to your wishes with timber, metal, ceramics, plastic and many other materials. The door basis for facade cladding is a Hörmann industrial sectional door ALR F42 with an aluminium frame construction and PU sandwich infill.

INDUSTRIAL SECTIONAL DOOR SPU F42 PLUS. This door version is the ideal solution for garages up to 7000 mm wide and for special fitting situations where an operator cannot be fitted above the door.



TOP. SPU F42 Plus M-ribbed, Silkgrain, Anthracite grey RAL 7016

LEFT. ALR F42 with on-site, flush-fitting cladding



Hinged garage doors

EASY ACCESS. With the double-leaf hinged garage doors, you can either open both leaves or one leaf in order to get your bike out of the garage, for example. Enjoy maximum comfort by equipping your hinged garage door with an operator. The thermally insulated sections provide good insulation and are available in all surface finishes.

→ For further information, see from page 75.



CUSTOMISED LEAF DIVISION. Design your hinged garage door entirely to suit your needs. The door leaves are available in both symmetrical and asymmetrical division. The symmetrical division, with door leaves of equal width, offers a harmonious door appearance. In the asymmetrical division*, the traffic leaf comes in a width of 870 mm, which allows easy pedestrian passage into the garage. The width of the fixed leaf results from the total width of the door. You can also choose to position the traffic leaf on the left or right side of the door.

* Up to 2000 mm door width





50

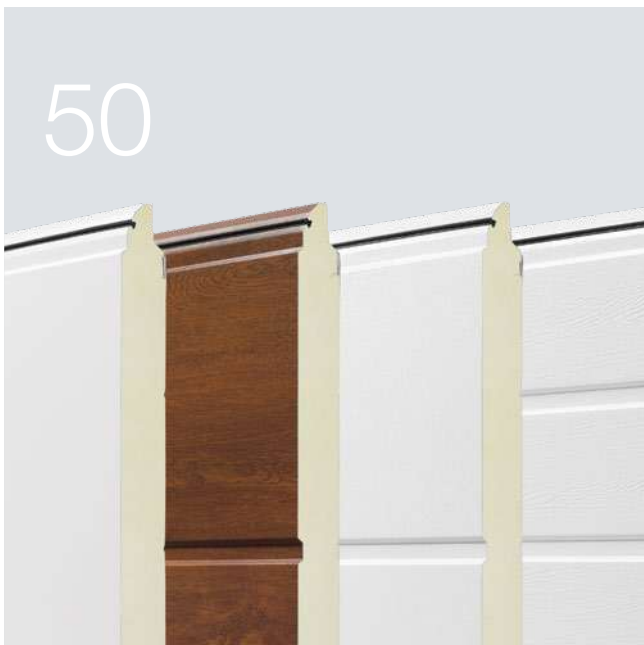

58

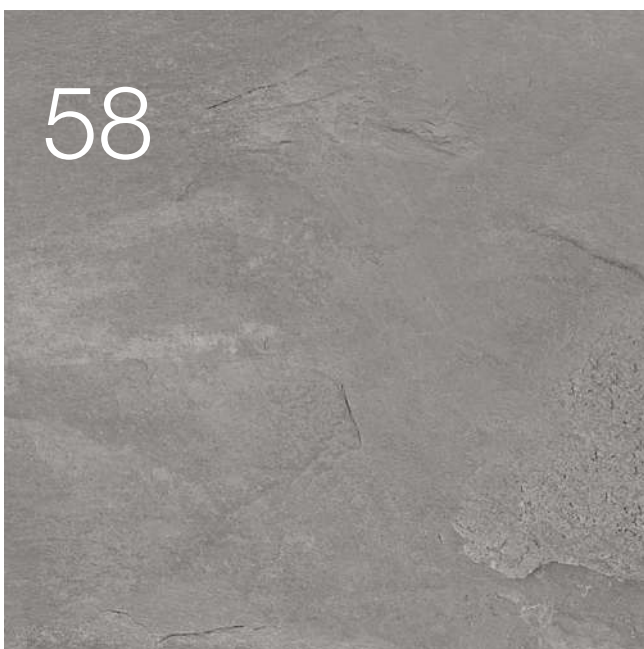

76



Design. Equipment. Accessories.

- 50 Steel sectional doors
- 56 Aluminium frame doors
- 57 Glazing
- 58 Surface finishes, colours, decors
- 66 Solid timber sectional doors
- 68 Equipment
- 72 Side doors
- 74 Wicket doors
- 75 Hinged garage doors
- 76 Operators
- 78 Accessories
- 80 Modernisation solutions
- 84 Dimensions and fitting data

Steel sectional doors

With maximum energy efficiency

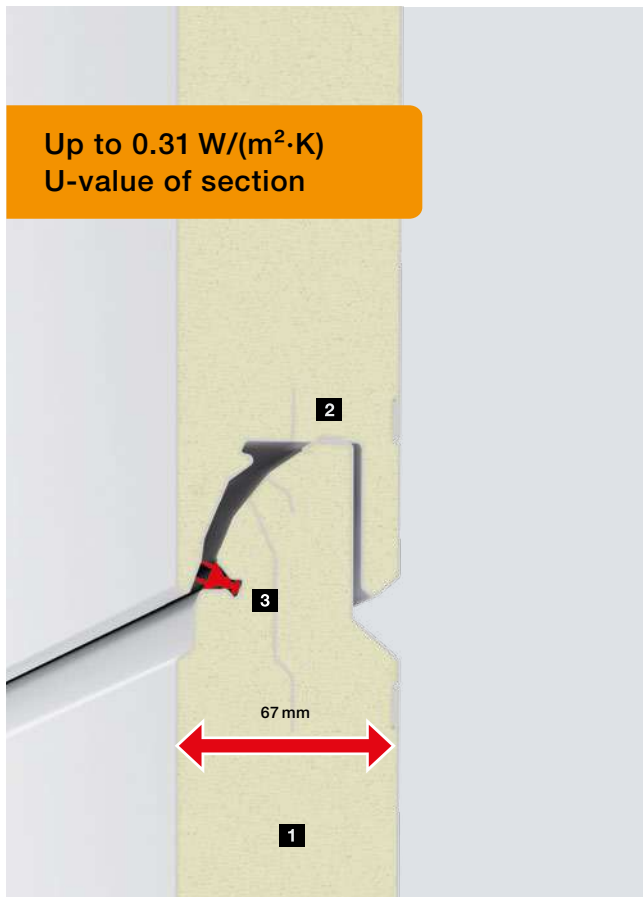

LPU 67 Thermo

Energy-saving door
with excellent thermal insulation

- 67 mm thick sections with thermal break **1**
- Supported sections **2** carry the door leaf weight
- Double lip seal in the section transitions **3**
- U-value of the door with ThermoFrame:
0.91 W/(m²·K)¹⁾
- Also available in Premium version (further information can be found on page 70)

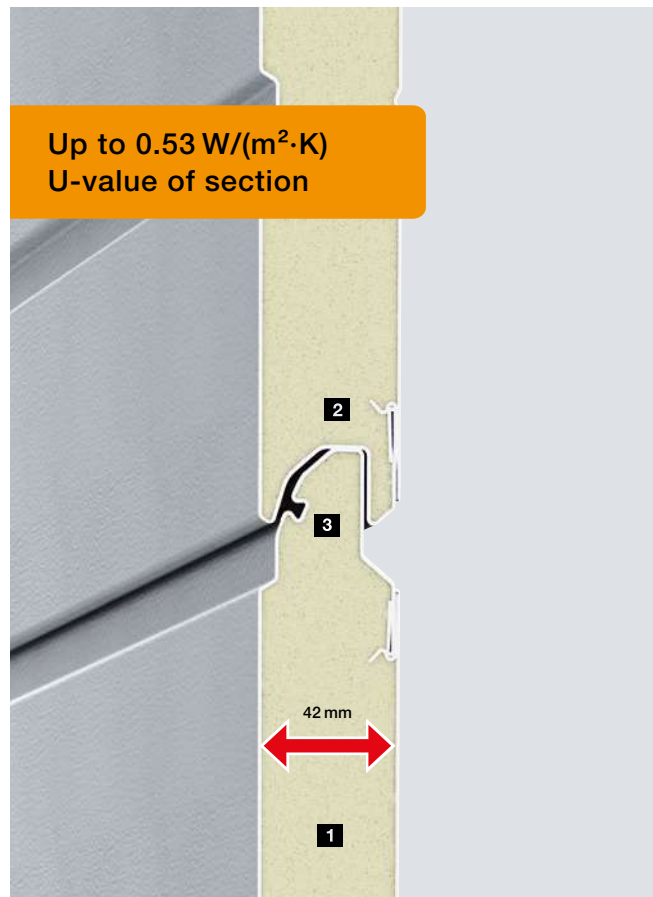

LPU 42

The bestseller
with excellent thermal insulation

- 42 mm thick sections **1**
- Supported sections **2** carry the door leaf weight
- Single lip seal in the section transitions **3**
- U-value of the door with ThermoFrame:
1.2 W/(m²·K)¹⁾
- Also available in Premium and PremiumPlus version (further information can be found on page 70)

Tip

The supra-fast operator SupraMatic 4 further reduces heat loss by opening the door at speeds of up to 25 cm/s. For further information, see page 76.

LPU 67 Thermo

LPU 42

Performance characteristics according to European standard 13241

Section material	Galvanized sheet steel with polyester-primer coating	Galvanized sheet steel with polyester-primer coating
Section thickness	Double-skinned, 67 mm	Double-skinned, 42 mm
Thermal insulation U-value fitted door	1.0 W/(m ² ·K) ¹⁾	1.3 W/(m ² ·K) ¹⁾
Acoustic insulation	Approx. 25 dB	Approx. 25 dB
Wind load ⁴⁾	Class 3	Class 3
Air / water tightness	Class 3 ³⁾ / class 3 ²⁾	Class 3 ³⁾ / class 3 ²⁾
Max. width Max. height	5000 mm 3000 mm	6000 mm 3000 mm

Styles / surface finishes

S-ribbed		Woodgrain
M-ribbed	Silkgrain, Decograin (3 decors)	Woodgrain, Slategrain, Silkgrain, Sandgrain, Decograin
L-ribbed	Silkgrain, Decograin (3 decors)	Woodgrain, Slategrain, Silkgrain, Sandgrain, Planar, Decograin, Duragrain
D-ribbed		Silkgrain
S-panelled		Woodgrain

¹⁾ The U-values apply to fitted doors without glazing with the dimensions 5000 × 2125 mm

²⁾ Up to 70 Pa water pressure

³⁾ Available for panelling and L-ribbing (LPU 42 doors with S-, M- or D-ribbing as well as with wicket door: class 2)

⁴⁾ Higher wind load classes on request

Surface finishes

Woodgrain, Slategrain and Silkgrain in Traffic white RAL 9016, 10 MatchColor preferred colours and 5 Color preferred colours



Sandgrain in 2 colours



Planar in 7 colours



Decograin in 6 decors



Duragrain in 30 decors



Steel sectional doors

Door leaf construction

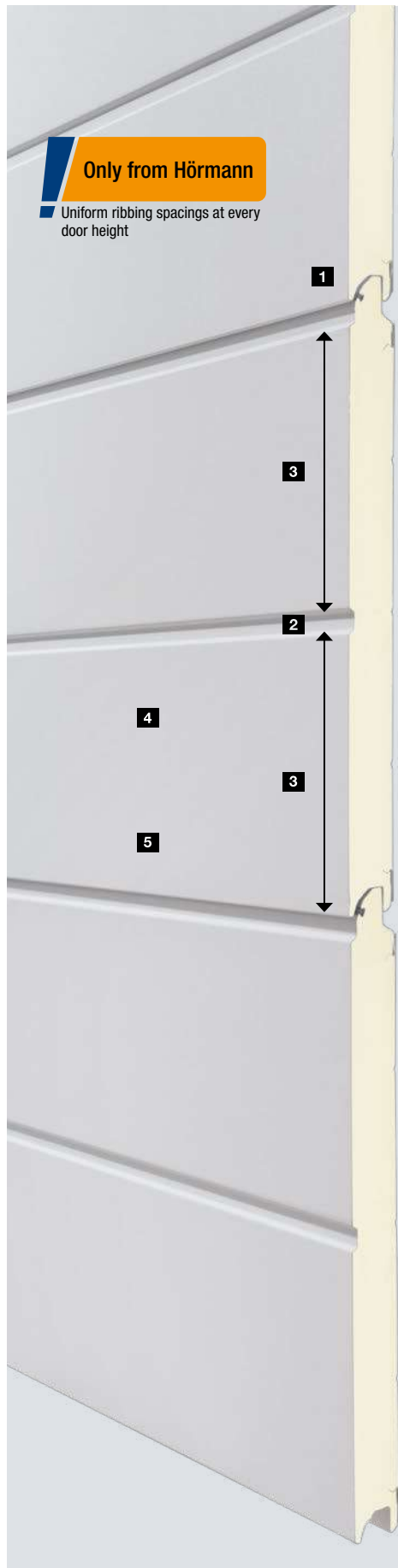

1 Section transition

The door leaf of a sectional door consists of several sections that are flexibly connected with a tongue-and-groove system. With Hörmann, the transitions are shaped so that they are practically invisible when the door is closed. See for yourself!

2 Ribbing

A ribbing is stamped into the exterior sheet of the section. It has the same view as a section transition.

3 Uniform spacings

For a particularly harmonious door appearance, Hörmann divides the ribbing and the section transitions evenly at every door height.

4 High-quality primer coating

The sections are optimally protected by the double-sided hot-galvanised sheet steel in conjunction with the high-quality polyester primer coating in Grey white RAL 9002 on the inside. For even better protection, you can also get the exterior of the sections with an optional protective coating (for more information, see page 59) or with all-round protection as the PremiumPlus version (for more information, see page 70). The high-quality Duragrain surface finish is offered with protective paint as standard.

5 Permanently beautiful door appearance

On the outside, depending on the surface, the high-quality polyester-primer coating, the UV-resistant plastic film coating or the final coating with high-strength protective paint gives your door a permanently beautiful appearance.

Standard styles



S-ribbed (LPU 42), Traffic white RAL 9016



D-ribbed (LPU 42), Traffic white RAL 9016



M-ribbed (LPU 67 Thermo, LPU 42), Traffic white RAL 9016



S-panelled (LPU 42), Traffic white RAL 9016



L-ribbed (LPU 67 Thermo, LPU 42), Traffic white RAL 9016

Steel sectional doors

Design elements for LPU 42 and LPU 67 Thermo

Styles with design elements



L-ribbed (LPU 67 Thermo, LPU 42), Traffic white RAL 9016, design element style 450, matching side door

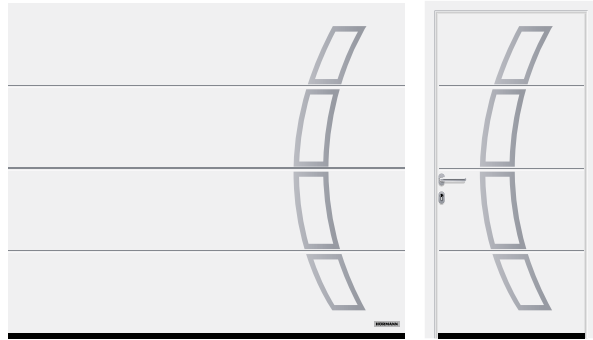

L-ribbed (LPU 67 Thermo, LPU 42), Traffic white RAL 9016, design element style 457, matching side door

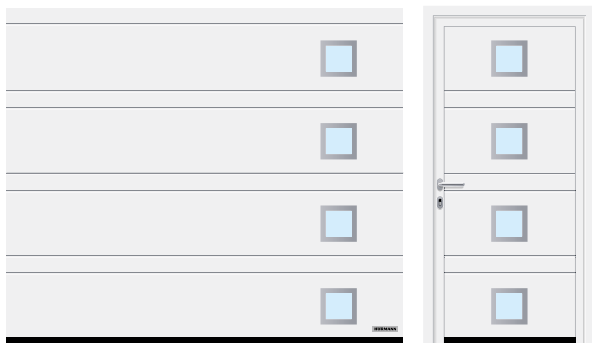

D-ribbed (LPU 42), Traffic white RAL 9016, design element style 461, matching side door

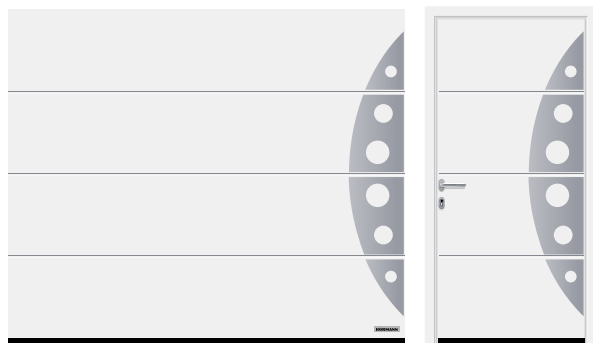

L-ribbed (LPU 67 Thermo, LPU 42), Traffic white RAL 9016, design element style 458, matching side door

Design elements

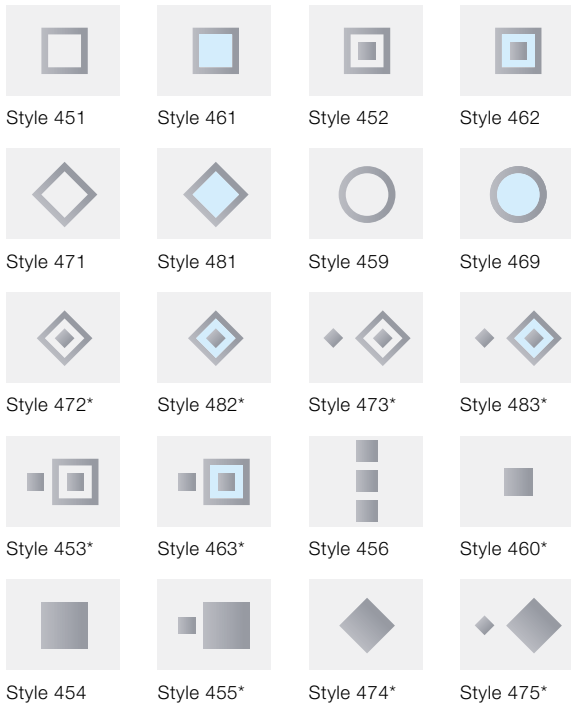

* Only LPU 42

Glazing



Design element in brushed stainless steel with optional real glass* for styles 461 and 481

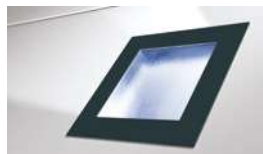

Design element painted in Anthracite grey RAL 7016 with synthetic glazing for styles 461, 462, 463, 469, 481, 482 and 483

Styles with inlay design elements



D-ribbed (LPU 42), Traffic white RAL 9016, inlay design element style 500 with divided inlays in timber look



D-ribbed (LPU 42), Traffic white RAL 9016, inlay design element style 502 in Steel blue RAL 5011



M-ribbed (LPU 42), Traffic white RAL 9016, inlay design element style 503 in stainless steel look



M-ribbed (LPU 42), Traffic white RAL 9016, inlay design element style 504 in timber look, in the wicket door

Inlay design elements



Stainless steel look



Timber look



RAL to choose (shown in RAL 9005)

Design elements "Numbers and words"



Positive view, modern font



Negative view, classic font

Aluminium frame doors

ART 42 / ART 42 Thermo / ART 42 Vitraplan **.NEW from 01.10.2023**

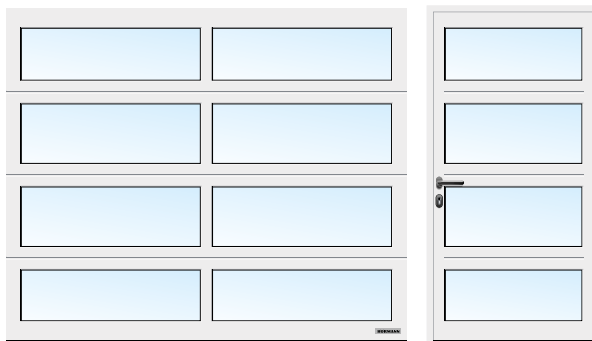

ART 42 glazed, Traffic white RAL 9016

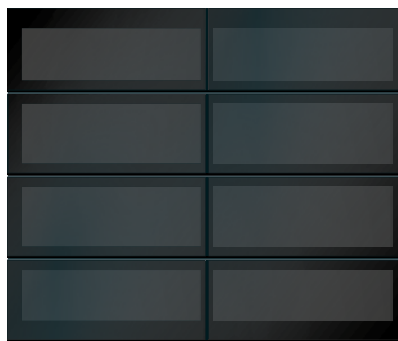

ART 42 Vitraplan, grey tinted

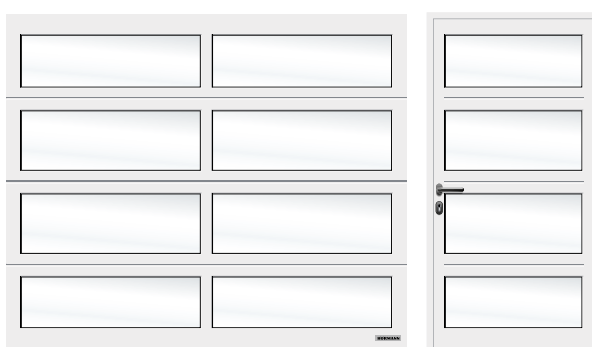

ART 42 glazed white tinted, Traffic white RAL 9016

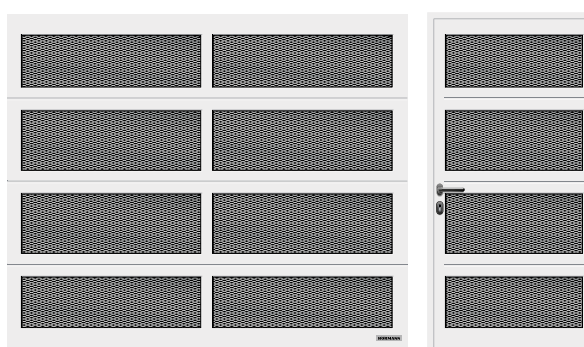

ART 42 with expanded mesh, Traffic white RAL 9016

Section view



ART 42

ART 42 Thermo

ART 42 Vitraplan
.NEW from 1.10.2023

ART 42 / ART 42 Thermo / ART 42 Vitraplan

Frame material	Aluminium
Frame thickness	42 mm
Thermal insulation ART 42 U-value fitted door	4.0 W/(m ² ·K) ¹⁾
Thermal insulation ART 42 Thermo U-value fitted door	3.4 W/(m ² ·K) ¹⁾
Acoustic insulation	R = approx. 20 dB
Wind load ³⁾	Class 3
Air / water tightness	Class 2 ²⁾ / class 3 ²⁾
Max. width	4000 mm
Max. height	3000 mm

¹⁾ U-values apply to fitted doors with synthetic double pane S2 with the dimensions 5000 × 2125 mm

²⁾ Doors with ventilation slots, classes 2 – 3 on request

³⁾ Higher wind load classes on request

Glazing variations



1



2



3



4



5



6



7



8



9

Glazing variants for LPU 42 and LPU 67 Thermo

- 1 Classic glazing S0¹⁾
- 2 Classic glazing M0¹⁾
- 3 Classic glazing L0¹⁾
- 4 Classic glazing S1
- 5 Classic glazing S2
- 6 Sunrise glazing S10³⁾
- 7 Sunrise glazing S60⁴⁾ (left door half shown)
- 8 Glazing type D¹⁾
- 9 Aluminium light strips²⁾

Infill variants for LPU 42, LPU 67 Thermo, ART 42 and ART 42 Thermo

- 10 Polycarbonate double pane, clear
- 11 Synthetic double pane, clear
- 12 Synthetic double pane, white tinted (opal / clear)
- 13 Synthetic double pane, crystal structure
- 14 Multiple-moulded pane
- 15 Synthetic double pane, grey tinted
- 16 PU sandwich infill, smooth
- 17 PU sandwich infill, Stucco
- 18 Perforated stainless steel sheet
- 19 Stainless steel expanded mesh
- 20 Crimped mesh
- 21 Welded grille

Glazings (1 to 8, 10) correspond to a door width of 2500 mm

- ¹⁾ Individual arrangement of glazings is possible
- ²⁾ Rails are possible
- ³⁾ Door width 2130 – 2750 mm
- ⁴⁾ Door width 4751 – 5500 mm

Infill variations



10



11

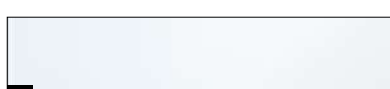

12



13

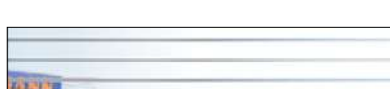

14



15



16



17



18



19



20



21

Clear synthetic glazings are available from Hörmann with Duratec glazing as standard.

It offers you decisive advantages:

- A permanently clear view
- Improved thermal insulation

Only from Hörmann



Duratec
Extremely scratch-resistant

Matching appearance

For door leaf and frame

Only from Hörmann

Door leaf, fascia panel and side frames matching in Woodgrain Traffic white RAL 9016

MATCHING APPEARANCE OF FRAMES AND DOOR LEAVES.

The harmonious appearance of a door is the result of many small details: The fascia panel **1** provided always matches the door sections for all surface finishes (except Slategrain). This ensures that everything fits together. The side frames **2** are available with a white Woodgrain surface finish as standard. With frame coverings **3**, the side frames can be easily adapted to the surface finish of the sections.

→ For further information on frame coverings, see from page 80.

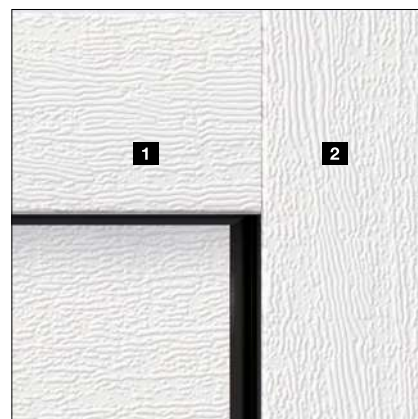

	Woodgrain	Slategrain	Silkgrain	Sandgrain	Planar	Decograin	Duragrain
Fascia panel 1	●	○	●	●	●	●	●
Side frame 2	●	■	■	■	■	■	■
Frame covering 3	●	●	●	●	●	●	●

● = Identical surface, colour or decor same as door section

■ = Woodgrain surface finish in Traffic white RAL 9016 (in Grey white RAL 9002 for the Premium version)

○ = Smooth surface finish in same colour as door section

Woodgrain



1

Slategrain

Only from Hörmann
Slategrain surface finish



2

Silkgrain

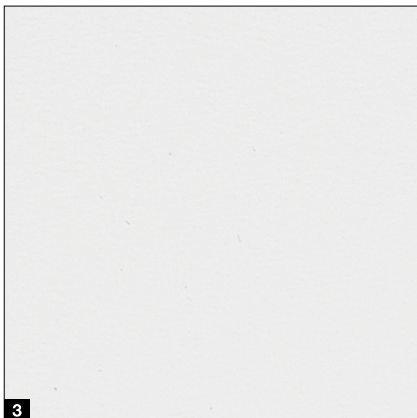

3

- 1 Woodgrain RAL 9016 Traffic white
- 2 Slategrain RAL 9016 Traffic white
- 3 Silkgrain RAL 9016 Traffic white

Protective paints for a long and beautiful door appearance

Final coating. The surface finish of the sections is especially robust, scratch-resistant and stain-resistant thanks to the protective paint.

“Anti-graffiti” final coating. Due to the protective paint on the surface of the section as well as on glazings, design elements, etc., graffiti can be removed with a commercially available special cleaner.

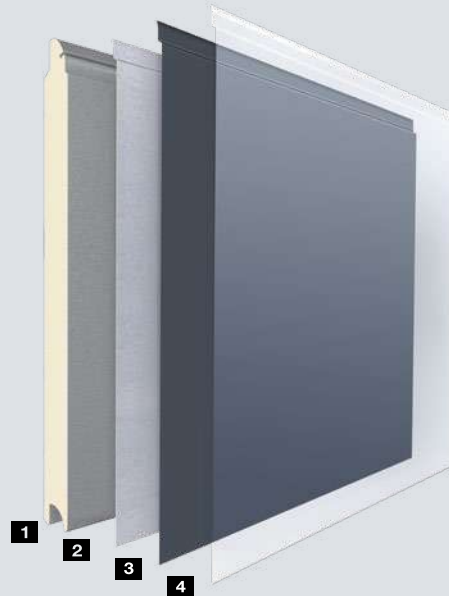

→ Available for Woodgrain, Slategrain and Silkgrain surface finishes.

- 1 Double-skinned section
- 2 Galvanisation
- 3 Polyester-primer coating
- 4 Final coating or “anti-graffiti” final coating

Cleaning and maintenance set for a long and beautiful door appearance

- Cleaner for doors (for cleaning all surfaces)
- Multi-purpose sponge, 2-in-1 polish for doors, application sponge, 2 × microfibre cloth, oil for doors

Before

After



Preferred colours

For the Woodgrain, Slategrain and Silkgrain surface finishes



MatchColor



MatchColor

MatchColor

Design your home in perfect colour harmony – with the MatchColor preferred colours for sectional garage doors, entrance doors, side doors and steel doors with a matching appearance. Enjoy the harmonious overall appearance thanks to matching colours. That is Hörmann brand quality!

Tip

The smooth Silkgrain surface finish harmonises particularly well with the entrance door surface finishes.

Please note:

In combination with an optional final coating or "anti-graffiti" final coating, all MatchColor preferred colours are available as a Color preferred colour for which a matching appearance of sectional garage doors, entrance doors, side doors and steel doors cannot be guaranteed.

Color

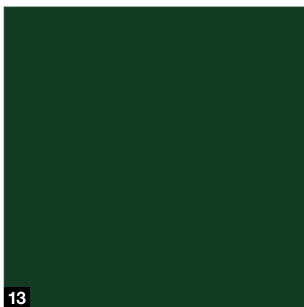
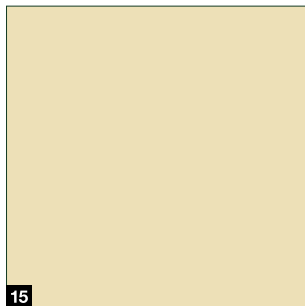
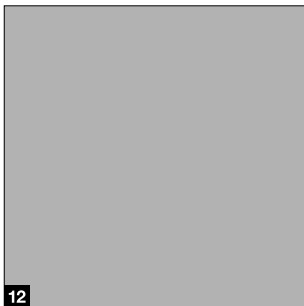
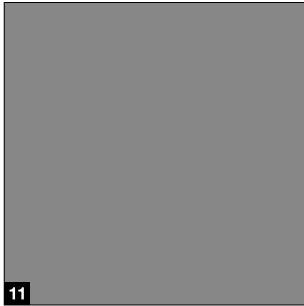

MatchColor .NEW

- 1 CH 703 Anthracite metallic
- 2 RAL 9005 Jet black
- 3 RAL 8028 Terra brown
- 4 RAL 7040 Window grey
- 5 RAL 7039 Quartz grey
- 6 RAL 7035 Light grey
- 7 RAL 7030 Stone grey
- 8 RAL 7016 Anthracite grey
- 9 RAL 7015 Slate grey
- 10 RAL 7012 Basalt grey

Color

- 11 RAL 9007 Grey aluminium
- 12 RAL 9006 White aluminium
- 13 RAL 6009 Fir green
- 14 RAL 6005 Moss green
- 15 RAL 1015 Light ivory

RAL to choose

The Woodgrain, Slategrain and Silkgrain surface finishes are optionally available in around 200 RAL Classic colours (with the exception of pearl-effect and fluorescent colours) as well as in many NCS and DB colours.

Please note:

Sectional garage doors are generally supplied in Grey white RAL 9002 on the inside of the door. Dark colours should not be used for double-skinned steel doors that are exposed to the sun, as possible section deflection may damage the door. All colours based on RAL. The colours and surface finishes shown are subject to the limitations of the printing process and cannot be regarded as binding.

Please consult with your local Hörmann sales partner.

Surface finishes

Sandgrain, Planar, Decograin

Sandgrain

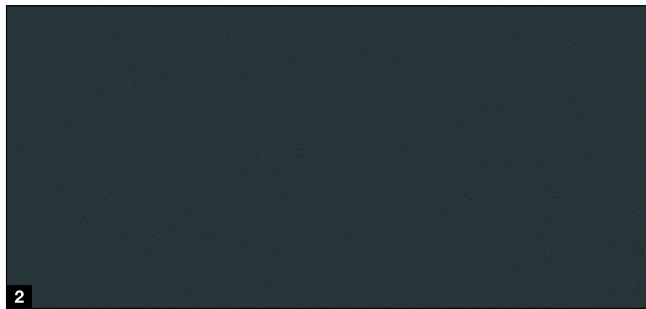
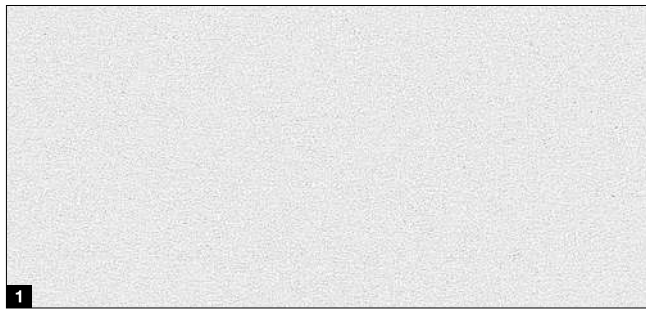

Planar

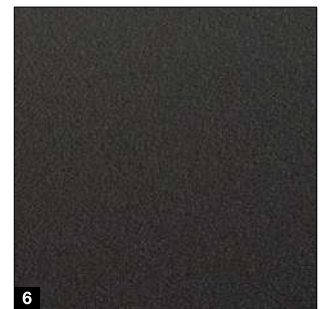
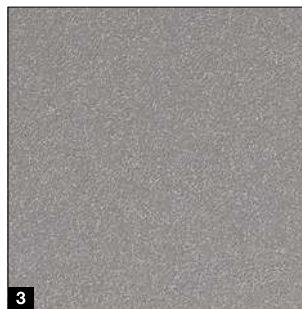
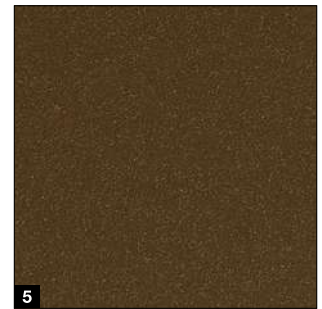
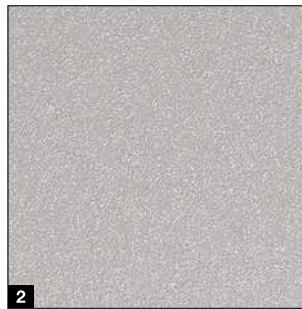
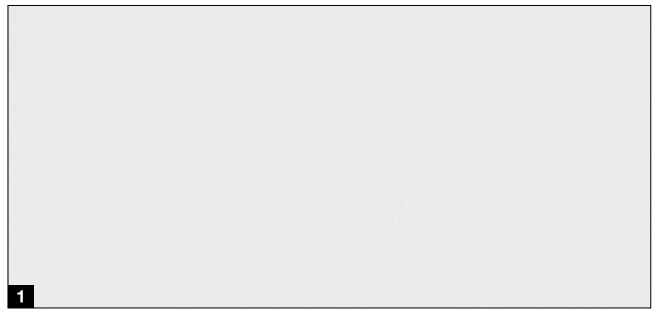

Decograin



Sandgrain standard colour

- 1 RAL 9016 Traffic white

Sandgrain preferred colour

- 2 RAL 7016 Anthracite grey

Planar standard colour

- 1 CH 9016 Matt deluxe Traffic white

Planar preferred colours

- 2 CH 9006 Matt deluxe White aluminium
- 3 CH 9007 Matt deluxe Grey aluminium
- 4 CH 7016 Matt deluxe Anthracite grey
- 5 CH 8028 Matt deluxe Terra brown
- 6 CH 703 Matt deluxe Anthracite metallic
- 7 CH 905 Matt deluxe black .NEW

Decograin decors

- 1 Titan Metallic CH 703: Anthracite with a metallic effect
- 2 Golden Oak: Medium brown, golden yellow oak design
- 3 Dark Oak: Walnut-coloured oak design
- 4 Night Oak: Dark, intense oak design*
- 5 Rosewood: Mahogany-coloured timber design*
- 6 Winchester Oak: natural-coloured knotty oak design*

* Not for LPU 67 Thermo

Please note:

Sectional garage doors are generally supplied in Grey white RAL 9002 on the inside of the door.

Dark colours should not be used for double-skinned steel doors that are exposed to the sun, as possible section deflection may damage the door. All colours based on RAL. The colours and surface finishes shown are subject to the limitations of the printing process and cannot be regarded as binding.

Please consult with your local Hörmann sales partner.

Surface finish

Duragrain

Duragrain

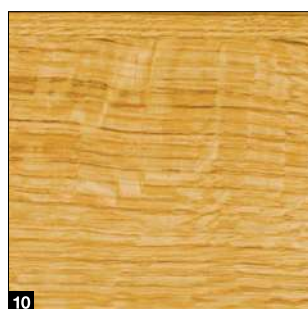
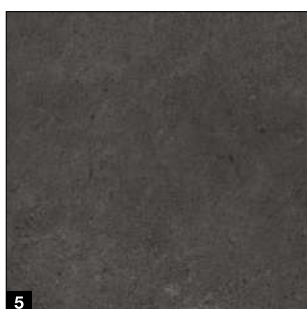
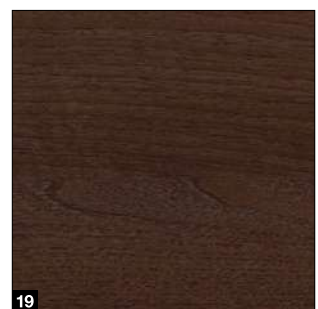
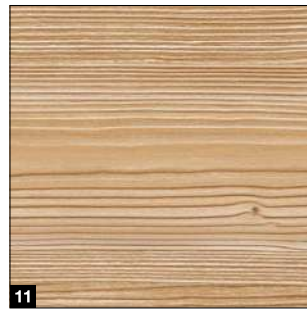
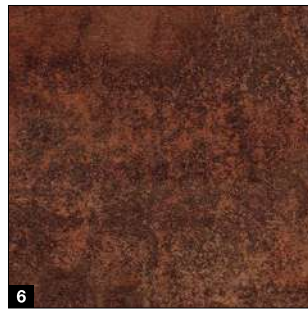
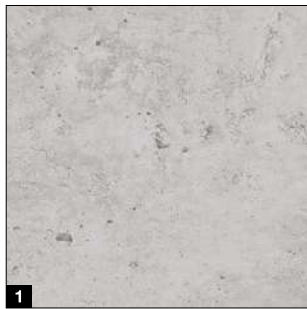

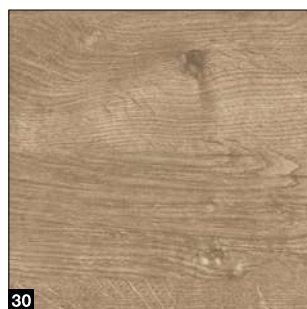
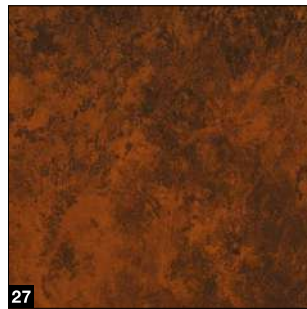
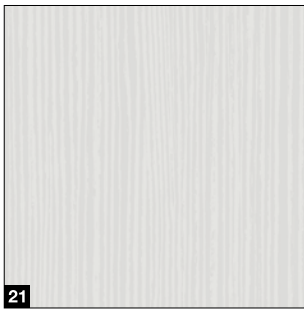

Duragrain decors

- 1 Concrete
- 2 Beige
- 3 Moca
- 4 Grigio
- 5 Grigio scuro
- 6 Rusty Steel
- 7 Bamboo
- 8 Burned Oak
- 9 Cherry
- 10 Nature Oak
- 11 Spruce
- 12 Rusty Oak
- 13 Noce sorrento balsamico
- 14 Noce sorrento natur
- 15 Sapeli
- 16 Sheffield
- 17 Teak
- 18 Used Look
- 19 Terra Walnut
- 20 Colonial Walnut
- 21 White brushed
- 22 White Oak
- 23 Whiteoiled Oak
- 24 Whitewashed Oak
- 25 Malt Oak
- 26 Cement **.NEW**
- 27 Rusty Patina **.NEW**
- 28 Barnwood **.NEW**
- 29 Barnwood grey **.NEW**
- 30 Wild Oak **.NEW**



For further information, see the "Duragrain surface finish" brochure.



Individual styles

Design your Duragrain door with your personal favourite style. To do this, simply upload your photo to www.hormann.co.uk/uk/home-owners-and-renovators/configurator or contact your Hörmann sales partner.

Solid timber sectional doors

LTH 42

Standard styles



S-ribbed



M-ribbed



L-ribbed



Panelled

LTH 42

Section material	Solid timber
Section thickness	42 mm
Thermal insulation U-value ¹⁾	2.9 W/(m ² ·K)
Wind load class ³⁾	3
Air / water tightness class ²⁾	0 / 0
Max. width	5000 mm
Max. height	3000 mm

¹⁾ The U-values apply to fitted doors without glazing with the dimensions 5000 × 2125 mm

²⁾ Doors with ventilation slots, classes 2 – 3 on request

³⁾ Higher wind load classes on request

Design styles



Style 401



Style 402

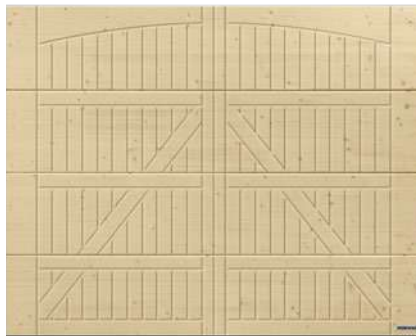

Style 405

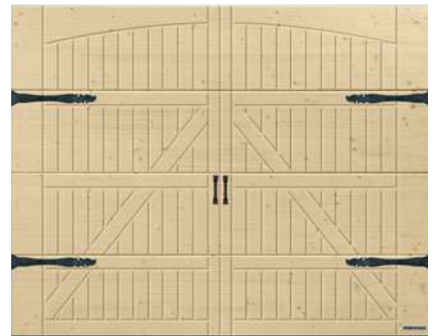

Style 405, with optional hinged door fitting kits "Exclusive"

Types of timber



Types of timber

- 1 Nordic Pine, untreated
- 2 Nordic Pine, brushed

Wood preservatives

- 3 Pine
- 4 Larch
- 5 Walnut
- 6 Sand beige
- 7 Silver

Coatings

- 8 RAL 9016 Traffic white
- 9 RAL 9001 Cream
- 10 RAL 7035 Light grey

Wood preservatives

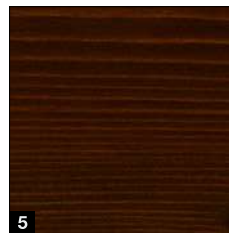
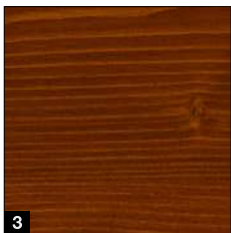

Coatings

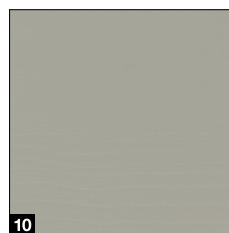
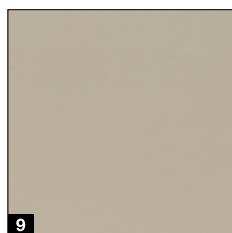
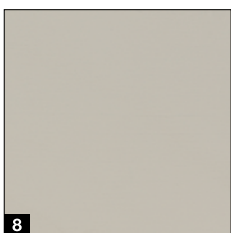

Please note:

Timber is a natural product. Durability depends on many factors such as: Type of weathering, constructive wood protection, mechanical load and the choice of colour. Timely maintenance work is required to achieve durability, therefore annual maintenance is recommended. Do not use dark glazes in direct sunlight. Keep the garage well ventilated.

All colours based on RAL. The colours and surface finishes shown are subject to the limitations of the printing process and cannot be regarded as binding.

Please consult with your local Hörmann specialised dealer.

Standard equipment

For a secure and long-lasting door function

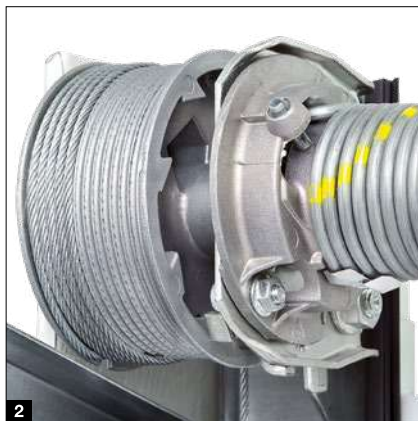

Tension spring technology with multi-spring system ¹

Up to 4000 mm door width and 2600 mm door height

The patented system reliably secures the door leaf from falling and prevents a broken spring from flying out and injuring people.

Torsion spring assembly with integrated spring safety device ²

From 4000 mm door width or 2600 mm door height as well as for doors with wicket door and for solid timber doors

The patented spring safety device stops the door travel immediately in the event of a spring breaking, thereby preventing the door leaf from falling.

Secure door guide in safety tracks ³

Patented, adjustable rollers, sturdy roller holders and safety tracks ensure that there is no danger of the door "derailing". The door leaf is safely parked under the ceiling.

Finger trap protection ⁴

On the inside, outside and on the hinges

The unique shape of the door sections eliminates trap points, both between the sections and on the hinges.

Trap guard on the side frames ⁵

With Hörmann, the frames are completely closed from top to bottom. There are no gaps between the door leaf and frame in which fingers could get trapped!

Only from Hörmann

European patent

Plastic frame shoe ⁶

A non-brittle, 4 cm plastic frame shoe covers the frame where it is prone to rusting and offers long-term protection against corrosion, even with waterlogging, which is unmatched by competitor solutions. Together with the door's bottom seal, the frame shoe makes for a bottom edge that is visually appealing.



Optional equipment

For greater convenience and safety

Premium version **1**

For LPU 42, LPU 67 Thermo, ART 42 and

ART 42 Thermo: For a beautiful interior view, the fittings, frames, tracks and the connection rail are painted matching the section interior in Grey white RAL 9002¹⁾. Twin rollers ensure very quiet and gentle door travel.

PremiumPlus version .NEW

For LPU 42: In addition to the Premium version, the all-round protection to minimize corrosion in maritime climates offers a section with final coating on the exterior and painted cut edges as well as ribbing infill profiles for better sealing on the section transitions and in the section area (for S-, M- and D-ribbing).

Ventilation slot on the topmost section **2**

For LPU 67 Thermo²⁾ and LPU 42²⁾ with operator

SupraMatic or ProMatic (from year of manufacture

2012): With the optional folding roller bracket, you only open the top section of your door to ventilate the garage. The bottom door section remains sealed on the ground, thus offering protection against small animals or leaves.

Emergency release lock **3**

For LPU 42 and LTH 42: You can use an emergency release lock to manually unlock your garage from the outside in an emergency. An inconspicuous round cylinder (cannot be integrated in the master key system) is connected to the emergency release of the operator boom on the inside.

Door handle for emergency release **4**

For all door versions: The door handle is equipped with a lock that can be integrated into the master key system. Use the handle to unlock the emergency release of the operator boom via a Bowden cable on the inside of the door. The door handles are available in the following versions: Black plastic, White cast aluminium, RAL 9016, Brushed stainless steel (see Fig.), Brown cast aluminium, RAL 8028.



ThermoFrame ⁵

For all door versions: The plastic profile can be easily fitted together with the door frame, creating a thermal break between the frame and brickwork, thus improving thermal insulation by up to 15%³⁾. In addition, extra sealing lips on both sides and in the upper section of the door lower the loss of heating energy from the garage interior.

- ¹⁾ Galvanized spring assembly incl. holder, spring safety device, cable drum, operator boom
- ²⁾ Only track application N, L, Z, not possible for doors with wicket door
- ³⁾ For a double-skinned sectional garage door LPU 42 with the dimensions 5000 × 2125 mm



RC 2 security features

As standard for LPU 67 Thermo, optional for LPU 42: The certified RC 2 security features make your door even safer and are recommended by police information centres.



Take a look at the video on YouTube or at www.hoermann.com/en/media-centre



Side doors

NT 60 / NT 80

Door sizes*

- Width (single-leaf)
990 – 1115 mm
- Width (double-leaf)
1130 – 3000 mm
- Height (single- / double-leaf)
1990 – 2183 mm

Leaf frames

- Narrow version **1**
(profile type 1, only for single-leaf side doors)
- Wide version **2**
(profile type 2)

Standard equipment

- 60 mm thick weather-resistant aluminium profiles in the colour of the sections **3** or, in the case of Duragrain infills, in a colour matching the decor
- Traffic leaf with black plastic lever handle set with oval rose escutcheons and profile cylinder lock **4**
- 3-way adjustable hinges optionally in black, white or aluminium natural finish **5**
- Fixed bolt for locking the fixed leaf with double-leaf side doors **6**

Optional equipment

- Concealed hinges for an elegant door appearance in the version with aluminium block frame **7**
- Break-in-resistant RC 2 security features with 3-point-locking (latch, bolt, 2 locking hooks) and security rose escutcheon for the version with wide leaf frame (profile type 2) **8**
- Double-leaf side doors with asymmetric division (traffic leaf always 870 mm wide in a size range of 1330 – 2000 mm RAMB)
- Lever handle or lever / knob handle sets in aluminium natural finish **9**, cast aluminium RAL 9016 **10**, brown cast aluminium **11**, brushed stainless steel **12** and black cast aluminium **.NEW 13**

* Depending on leaf frame version





Insulated version NT 80

- Aluminium profile system, frame and threshold rail with thermal break
- 80 mm depth



Multi-purpose door MZ Thermo

- Door leaf and frame with thermal break
- Excellent thermal insulation value of $1.2 \text{ W}/(\text{m}^2 \cdot \text{K})$.
- Optionally in RC 2 version (KSI Thermo)



For further information, see the "Steel doors" brochure.

Wicket doors

With trip-free threshold

Door versions

- LPU 42 with track application N (up to 5 m door width)
- LPU 42 with track application Z (up to 2.5 m door width) **.NEW**

Clear opening widths

- Width 830 mm
- Width 1140 mm

Standard equipment

- Aluminium door frame in anodised natural finish **1**
- Sturdy hold-open device prevents door leaf dropping and warping **2**
- Concealed hinges for a uniform door appearance **3**
- Slide rail door closer incl. integrated opening limiter and hold-open device **4**

Optional equipment

- Aluminium door frame in RAL to choose (also different from the door colour) or painted to match the colour of the decor (Planar, Decograin, Duragrain surface finishes)
- Integrated door closer incl. hold-open device for optimum protection and the best appearance **5**
- Multiple-point locking with one bolt and hook bolt per section for better stability and improved break-in resistance **6**
- Leading photocell VL 2 stops the door without contact and increases safety **7**



Please note:

In some cases, adjacent panelled doors with the same width, with or without wicket door, may not have a uniform panel spacing. Manually operated garage doors with wicket door do not have an exterior door handle. They are locked from the inside.



Door sizes

- Width 1330 – 3000 mm
- Height 1960 – 2500 mm

Standard equipment

- Door infill made of 42 mm thick sections **1**
- For S-ribbed, M-ribbed, L-ribbed, D-ribbed and T-ribbed in all colours and decors
- 60 mm thick aluminium frame profiles in section colour (for Decograin and Duragrain infills in a colour matching the decor) **2**
- 3 sturdy hinges per door leaf (one hinge secured) in aluminium colour **3**
- 3-sided double door seal and double lip seal in the threshold area **4**
- Traffic leaf with aluminium lever handle set and profile cylinder lock **5**
- Fixed leaf with door espagnolette lock **6**

Optional equipment

- Mechanical hold-open device for traffic and fixed leaf for fixing the leaves in open position **7**
- Mechanical hold-open device with braking and damping function to prevent the leaves from uncontrolled slamming and opening and fixing in any desired position **8**
- Concealed hinges for an elegant door appearance

Operator equipment

- Hinged door fitting kit incl. cover for operators ProMatic 4 or SupraMatic 4 **9**
- Concealed hinges
- Finger guard or trap guard for an excellent safety inside **10**

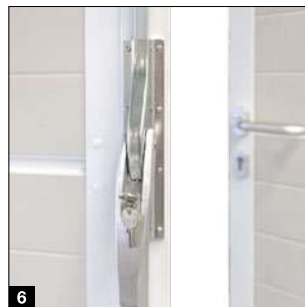
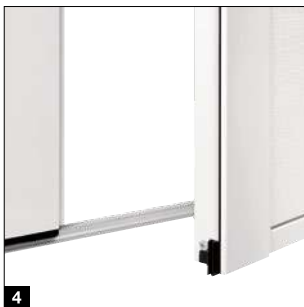

Operators

SupraMatic 4

Supra-fast door opening and smart additional functions

- 75% faster opening speed* up to 25 cm/s resulting in reduced heat loss
- Smart operation with the BlueSecur app
- Convenient garage ventilation
- Additional opening height
- Up to 3 times (SupraMatic E) or 5 times* (SupraMatic P) brighter LED lighting
- Easy-to-use programming thanks to 2 x 7-segment display
- High-quality stainless steel operator cover
- Networked with Smart Home systems via the standard HCP interface
- Low power consumption in standby below 1 watt



BiSecur

As standard with two 4-button hand transmitters HSE 4 BS, textured surface black with chrome caps

Garage door operators	SupraMatic E	SupraMatic P
Bluetooth receiver	Integrated, can be switched on and off	Integrated, can be switched on and off
HCP bus connection	Integrated	Integrated
Cycles per day / hour	25 / 10	50 / 10
Pull and push force	650 N	750 N
Peak force	800 N	1000 N
Max. opening speed	25 cm/s	25 cm/s
Lighting	20 LEDs	30 LED chase light
Max. door width	5500 mm	6000 mm
Max. door surface	13.75 m ²	15 m ²

* In comparison with the ProMatic series 3

Only from Hörmann
European patent

Hörmann BlueSecur



Operation by smartphone using the Hörmann BlueSecur app

Premium quality at an attractive price

- 40% faster opening speed* up to 20 cm/s
- Convenient garage ventilation
- Additional opening height
- Up to 2 times* brighter LED lighting
- Networked with Smart Home systems via the standard HCP interface
- Low power consumption in standby below 1 watt



 **BiSecur**

4-button hand transmitter HSE 4 BS, black textured surface with plastic caps as standard

Garage door operators	ProMatic 4	ProMatic 4 Akku
Bluetooth receiver	Optional (HET-BLE)	Optional (HET-BLE)
HCP bus connection	Integrated	Integrated
Cycles per day / hour	25 / 10	5 / 2
Pull and push force	600 N	500 N
Peak force	750 N	600 N
Max. opening speed	20 cm/s	16 cm/s
Lighting	10 LEDs	10 LEDs
Max. door width	5000 mm	4000 mm
Max. door surface	11.25 m ²	9 m ²

ProMatic 4 Akku

For garages without power connection



Akku with solar module

Accessories

Hand transmitter



HS 5 BS
4 button functions plus query button, high-gloss surface black or white



HS 5 BS
4 button functions plus query button, textured surface matt black



HS 4 BS
4 button functions, textured surface matt black



HS 1 BS
1 button function, textured surface matt black



HSE 1 BS
1 button function, including eyelet for key ring, textured surface matt black



HSZ 4 BS
4 button functions, incl. eyelet for key ring, textured surface matt black with chrome or plastic caps



HSE 4 BS
4 button functions, incl. eyelet for key ring
High-gloss surface with chrome caps, colours (shown from left): White, Anthracite grey, Frozen grey, Classic grey, Carbon, Silver



HSD 2-C BS
High-gloss chrome, 2 button functions, can also be used as a key ring



HSZ 1 BS / HSZ 2 BS
1 or 2 button functions, for insertion in vehicle cigarette lighter



HSI 3 BS .NEW
To control up to 3 doors, with extra-large buttons, impact-resistant housing, protection category: IP 65



**Radio code switch
FCT 3 BS**
3 functions, with illuminated buttons, recessed or surface-mounted fitting possible, plastic housing in Light grey RAL 7040 (also available with 10 functions and hinged cover, painted in White aluminium RAL 9006)



**Radio code switch
FCT 10 BS**
10 functions, with illuminated buttons and hinged cover, recessed or surface-mounted fitting possible, plastic housing painted in RAL 9006 White aluminium



**Radio finger-scan
FFL 25 BS**
2 functions and up to 25 fingerprints, with hinged cover, recessed and surface-mounted fitting possible, plastic housing painted in RAL 9006 White aluminium



**Radio internal push button
FIT 5 BS**
4 button functions plus query button, plastic housing in Pure white RAL 9010

Button



**Radio internal push button
FIT 2-1 BS**
2 functions, connection option for max. 2 control elements via cable, e.g. key switch, plastic housing in Pure white RAL 9010



**Internal push button
IT 1b-1**
Large, illuminated button for convenient opening of the door, plastic housing in Pure white RAL 9010



**Transponder key switch
TTR 1000-1**
1 function, 1000 teachable keys, scope of delivery: 1 key and 1 card (more on request), zinc die-cast housing in White aluminium RAL 9006



**Code switch
CTP 3-1**
3 functions, with illuminated lettering and touch-sensitive black surface, zinc die-cast housing in White aluminium RAL 9006



**Code switch
CTV 3-1**
3 functions, particularly robust with metal keypad, zinc die-cast housing in White aluminium RAL 9006 with stainless steel panel



**Finger-scan
FL 150**
2 functions, control via fingerprint, up to 150 savable fingerprints, zinc die-cast housing in White aluminium RAL 9006 with stainless steel panel



Key switch
1 STUP 50
2 STAP 50
Recessed version and surface-mounted version, incl. 3 keys, zinc die-cast housing in White aluminium RAL 9006 with stainless steel panel



Internal climate sensor HKS1
For monitoring humidity and automatic ventilation of the garage, plastic housing in Pure white RAL 9010
External sensor HKSA
For measuring outdoor humidity, plastic housing in Pure white RAL 9010

Modernisation solutions

For special fitting situations

Standard fitting **1**

Ideally, the available garage has at least 90 mm sideroom. The frame can then be screwed directly into the wall behind the opening. Hörmann sectional doors come with all the necessary fitting materials.

Frame support set **2**

The plastic profile is fitted between the frame and brickwork. In the case of damp exterior walls, this prevents the transfer of moisture to the frame and effectively prevents the formation of rust.

Frame coverings

For a harmonious overall appearance, the side frames with frame coverings can be easily adapted to the surface finish of the sections.

3 55 mm wide frame covering incl. adhesive pads for easy fitting behind the opening, with little sideroom (< 90 mm)

4 90 mm wide frame covering for fitting in the opening, flush with the wall

Special anchor for frame side fixing

The sectional door frame can be fitted to the side wall of the garage with the optional, universally applicable anchors. Irregularities in the wall can be easily compensated, leaving the reveal intact.

3 Fitting with up to 35 mm wall spacing

4 Fitting with angled or irregular side wall

5 Fitting with thermal insulation composite system

6 Fitting with non-load-bearing facades (facing brick or thermal insulation) with sideroom of 90 to 125 mm and fixing depths of 160 to 240 mm (depending on the anchor version).



Wind threshold **7**

The profile is simply fitted to the floor and additionally seals off the door bottom edge. This prevents the penetration of water across the full door width. The low height ensures barrier-free access.

Compensation sets for uneven floors **8**

The adjustable bottom profile compensates the bottom edge of the door leaf up to a height difference of 20 mm. The set for frame compensation consists of 2.5 mm thick plastic plates, which are positioned to fit perfectly under the frame shoes.

Replacement of up-and-over doors

When removing an old up-and-over door and fitting a new LPU 42 sectional door, a time-consuming process is often necessary to straighten the ground. With our modernisation solutions this work is no longer needed.

Renovation threshold rail **9**

Replaces the old threshold rail of an up-and-over door for a clean bottom edge to the garage floor.

Low-track door set **10**

The set consists of a compensation profile and special door hardware. The frame must be shortened by 25 mm if the set is used. This can either be ordered in the desired dimensions or shortened on site.

Reno RC set **11**

The rear part of the plastic frame shoe is notched so that it can be fitted on the floor rail of the old up-and-over door. The set consists of a special buffer piece and a specially shaped bottom seal that neatly seals the door in front of the threshold rail.

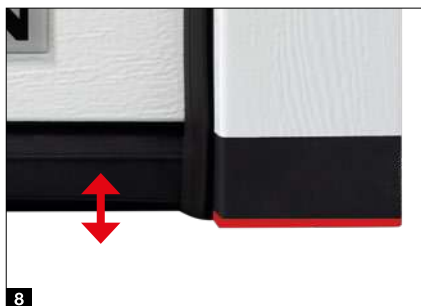

Modernisation solutions

With elegant panels

Fascia panel ¹

Ideally, the available garage has at least 100 mm of clearance in the lintel area (at least 115 mm for doors with operator). The fascia panel for standard fitting behind the opening is supplied with a height of 95 mm as standard. The panel is also available with a height of 125 mm on request.

Double-skinned fascia panel ²

A matching, double-skinned fascia panel for fitting in the opening covers a larger gap between the ceiling and the fascia panel. Glazings are also possible after technical clarification. This panel can be optionally supplied as an aluminium light strip.

Flush-fitting fascia panel ³

For LPU 42 doors, a flush-fitting fascia panel is the most elegant solution for an invisible transition between the panel and door leaf. When the door is closed, the top door section is flush with the panel.

Fascia frame set for lintel and side wall

A door in an inexpensive standard or modernisation size can be fitted in the opening. The remaining gap between the lintel and top door section or side wall and side frame (max. 30 mm) is covered using an optional fascia frame set. This set comes with fascia panels, end caps and fixing material. The side frame is additionally covered with an optional frame covering:

⁴ 95 mm width for fitting in the reveal

⁵ 125 mm width for fitting in front of the reveal.

Retrofit fascia set ⁶

Unattractive gaps and broken masonry in the lintel and reveal can be covered easily and neatly with the optional retrofit fascia. Additional brickwork and plastering work are no longer required.



	Woodgrain	Slategrain	Silkgrain	Sandgrain	Planar	Decograin	Duragrain
Frame covering	●	○	●	●	●	●	●
Fascia panel	●	○	●	●	●	●	●
Fascia panels	●	●	●	●	●	●	●
Fascia frame set	●	○	●	●	●	●	●
Flush-fitting fascia panel	●	●	●	●	●	●	●
Retrofit fascia set	●	○	●	●	●	●	●

● = Identical surface, colour or decor same as door section
○ = Smooth surface in the same colour as the door section



Vertical views (with operator)

Track application Z

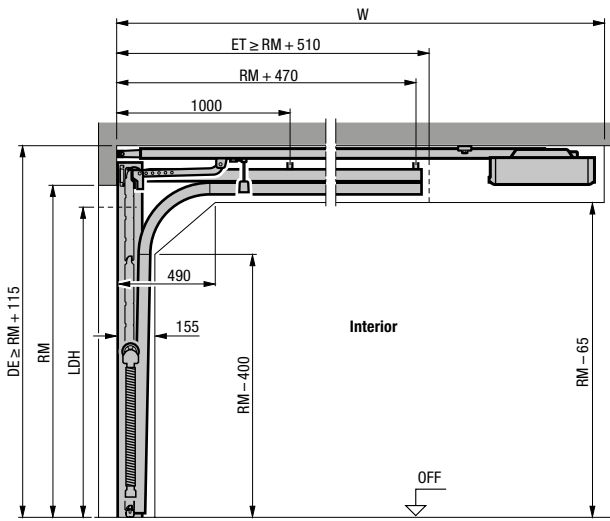

Track application N

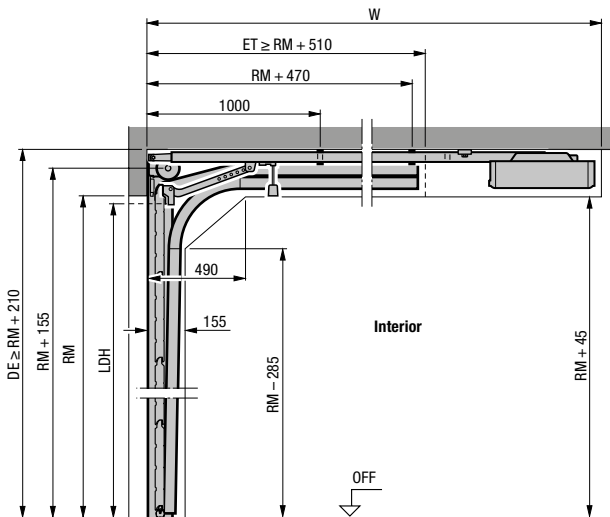

Track application L

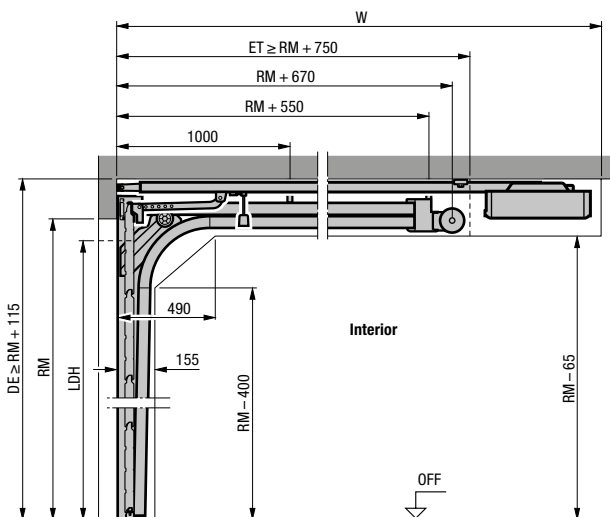

Horizontal view

Track application Z, N, L

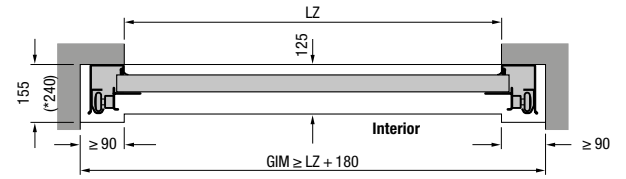

Fitting with track application Z, N, L

Overall length with operator (W)	Track application Z	Track application N	Track application L
Doors with operator			
2125 (K)	3200	3200 ¹⁾	3200
2250 (K)		3200 ²⁾	
Max. door height	2375 (M)	3450	3450 ¹⁾
	2500 (M)		3450 ²⁾
	2600 (L)	4125	
3000 (L)		4125	4125

¹⁾ Max. door height only for LPU 67 Thermo

²⁾ Max. door height only for LPU 42

Explanations

Operator booms

- K Short boom
- M Medium boom
- L Long boom

Ordering sizes

- LZ Clear frame dimension
- RM Grid height
- DE Ceiling height
- W Overall length with operator
- LDH Clear passage height
- GIM Inside garage dimension
- ET Distance back
- OFF Finished floor level

Note:

The operator should be fitted 40 mm higher for dark coloured doors exposed to the sun.

Please note the deviating dimensions in the technical manual for doors LPU 42 with RC 2 security features, door leaf weights of over 170 kg or door widths of over 5000 mm and for doors LPU 67.

For track applications such as high-lift track applications as well as further information, please see the technical manual or contact your Hörmann partner.

Dimensions and fitting data

Side doors

Horizontal views

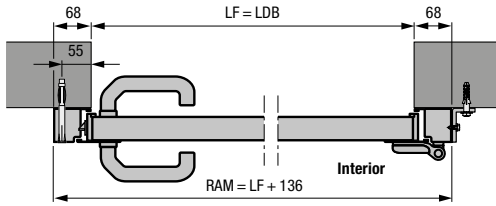

Side door with aluminium block frame, profile type 1
Fitting behind the opening

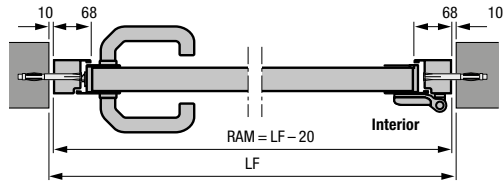

Side door with aluminium block frame, profile type 2
Fitting in the opening

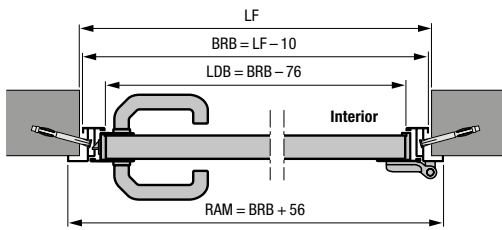

Side door with aluminium corner frame, profile type 1 or 2
Internal fitting

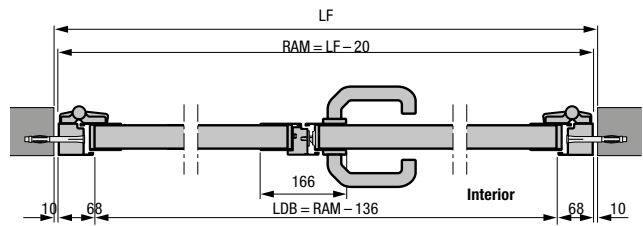

Double-leaf side door with aluminium block frame, profile type 2
Fitting in the opening

- Double-leaf side door with asymmetrical division
- Double-leaf side door opening inwards and outwards

Vertical views

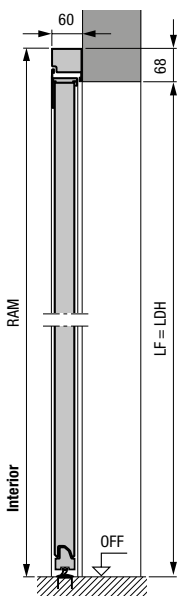

Side door with aluminium block frame, profile type 2
Fitting behind the opening

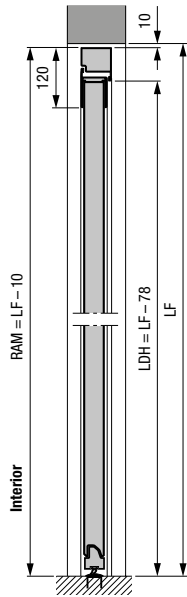

Side door with aluminium block frame, profile type 2
Fitting in the opening

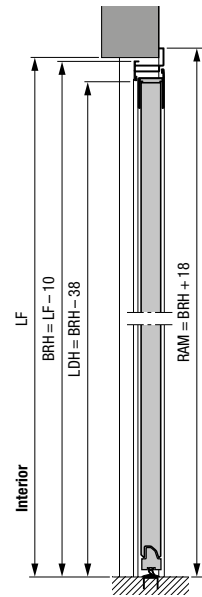

Side door with aluminium corner frame, profile type 2
External fitting

Dimensions in mm

Steel side doors

Profile type 1 (fitting behind the opening) with S-, M-, L-ribbing, S-panelled, block frame

LF of the opening	Ordering size = RAM	Lever height* from OFF	Door section height B
855 – 875 × 1990 – 2000	990 × 2058	955	500
855 – 875 × 2115 – 2125	990 × 2183	1010	531
980 – 1000 × 1990 – 2000	1115 × 2058	955	500
980 – 1000 × 2115 – 2125	1115 × 2183	1010	531

Profile type 2 (fitting behind the opening) with S-, M-, L-, D-ribbing, S-panelled, block frame

LF of the opening	Ordering size = RAM	Lever height* from OFF	Door section height B
855 – 875 × 1990 – 2000	990 × 2058	1050	500
855 – 875 × 2115 – 2125	990 × 2183	1050	531
980 – 1000 × 1990 – 2000	1115 × 2058	1050	500
980 – 1000 × 2115 – 2125	1115 × 2183	1050	531

Profile type 2 (fitting in the opening) with S-, M-, L-, D-ribbing, block frame

LF of the opening	Ordering size = RAM	Lever height* from OFF	Door section height B
875 × 2000	855 × 1990	1050	500
875 × 2125	855 × 2115	1050	531
1000 × 2000	980 × 1990	1050	500
1000 × 2125	980 × 2115	1050	531

Profile type 1 (only opening inwards, internal fitting) with S-, M-, L-ribbing, S-panelled, corner frame

Ordering size = BRM	Lever height* from OFF	Door section height B
875 × 2000	955	500
875 × 2125	1010	531
1000 × 2000	955	500
1000 × 2125	1010	531

Profile type 2 (internal or external fitting) with S-, M-, L-, D-ribbing, corner frame

Ordering size = BRM	Lever height* from OFF	Door section height B
875 × 2000	1050	500
875 × 2125	1050	531
1000 × 2000	1050	500
1000 × 2125	1050	531

Explanations

P1	Profile type 1 (narrow leaf frame)
P2	Profile type 2 (wide leaf frame)
LDB	Clear passage width
LDH	Clear passage height
RAM	Overall frame dimension
LF	Structural opening
BRM	Nominal size
BRB	Nominal size width
BRH	Nominal size height
OFF	Finished floor level

Special sizes

Single-leaf side doors:

On request

Double-leaf side doors:

1330 – 2500 × 1960 – 2558 mm

* You can find the lever heights for special sizes in the technical manual.

Experience Hörmann quality in new construction and modernisation

Hörmann products have impressive durability and high functionality. You can easily plan for new construction as well as modernisation. The carefully coordinated solutions make your home more beautiful, more secure and more comfortable.

**GARAGE DOORS. DOOR OPERATORS. ENTRANCE DOORS. RESIDENTIAL INTERNAL DOORS.
STEEL DOORS. FRAMES. STORAGE SPACE SYSTEMS.**



Some of the products shown are equipped with special equipment and do not always correspond to the standard versions. The surface finishes and colours shown are subject to the limitations of the printing process and cannot be regarded as binding. All rights reserved. No part may be reproduced without our prior permission. Subject to changes.